

How to Build an Ultra-Fast High-Power Laser Driver - That Sees Farther, Better, and at a Lower Cost!



Application

Light Detection and Ranging (LiDAR) is a remote sensing technology which transmits pulses of light from the sensor and measures the reflection to determine the location and distance of objects, as shown in figure 1.

For applications such as autonomous and assisted driving, one needs short pulses to achieve the necessary distance resolution – as short as a few nanoseconds or even less. These pulses are typically generated using a laser diode. To get sufficient range, the peak optical power must be high, which means laser diode current peak values of 10s to 100s of amps. Until recently, this required the use of complex circuits and unusual, expensive semiconductors.

With the advent of eGaN® FETs, the desired performance becomes possible with simple, small circuits at low costs. Three of the most popular FETs for LiDAR are the [EPC2036](#), [EPC2212](#) and the [EPC2001C](#), shown in figure 2. The extremely high performance of GaN and the ultra-low inductance of the chip-scale package make eGaN FETs the ideal switches for pulsed laser drivers.

How to do it

The simplest and most common laser driver is the resonant capacitive discharge driver, shown in figure 3. FET Q_1 discharges C_1 resonantly through the stray inductance L_1 and laser D_L . To overcome inductance L_1 and achieve the fast current rise-time desired, C_1 is charged to a relatively high voltage (usually 25 V to 150 V). FET Q_1 must be able to withstand the voltage, conduct the peak current, and turn on in 1 ns or less. The eGaN FET is the only readily available, cost-effective semiconductor switch that can meet these requirements.

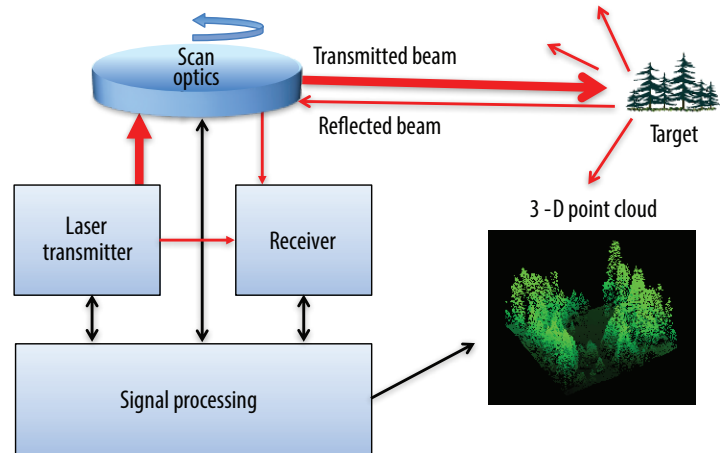

Figure 1. Overview of a typical LiDAR system

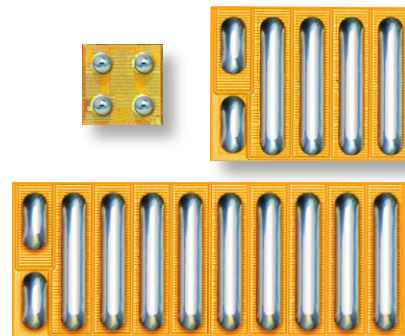

Figure 2. The EPC2036, EPC2212 and EPC2001C are popular in autonomous vehicle LiDAR systems

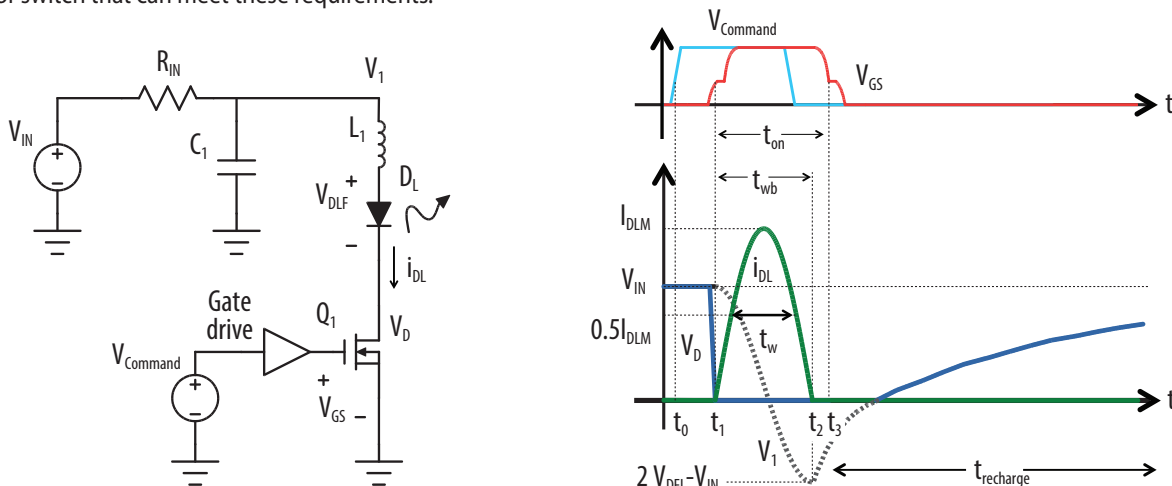

Figure 3. Simplified laser driver with key waveforms

The EPC9126 and EPC9126HC laser driver demonstration systems are designed to minimize inductance using the same basic optimal layout principles recommended for EPC power conversion applications. The EPC9126 comes populated with the EPC2212 and generates 35 A pulses less than 4ns wide into a triple junction laser. Its high current companion, the EPC9126HC, can generate pulses of 65 A that are less than 8 ns wide. Both drivers have built-in sensing of key waveforms and can accommodate multiple laser packages. Figure 4 shows the EPC9126/HC.

For the utmost in performance, one can optimize the PCB for a particular laser and pair with a high-performance gate drive such as the Texas Instruments LMG1020. Using a low inductance surface mount laser such as the Excelitas TPGAD1S09H, the EPC2212 can achieve 26 A, 1.8 ns pulses (figure 5). For very high peak power (> 4 kW), the

200 V EPC2034C, with a pulse current rating of 160 A, can achieve 8 ns, 155 A pulses with the same driver and laser (figure 6).

Automotive qualified parts

For automotive lidar applications, EPC has released a family of AEC-Q101 qualified devices ranging from 15 V - 100 V. This product family will continue to expand. For the latest selection of AEC-Q101 qualified FETs and ICs please visit the [EPC website](#).

For more information

Lidar is a rapidly changing technology and the performance limits have not been reached. Keep your sensors on the lookout for new advances and check the EPC website frequently!

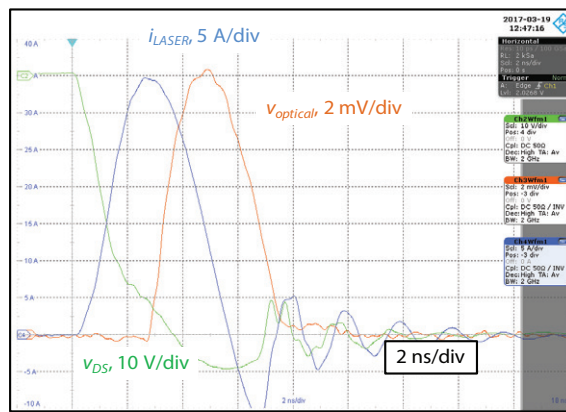
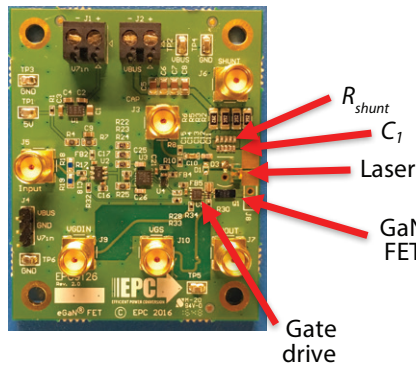

Figure 4. EPC9126 laser driver demonstration board system with measured waveforms

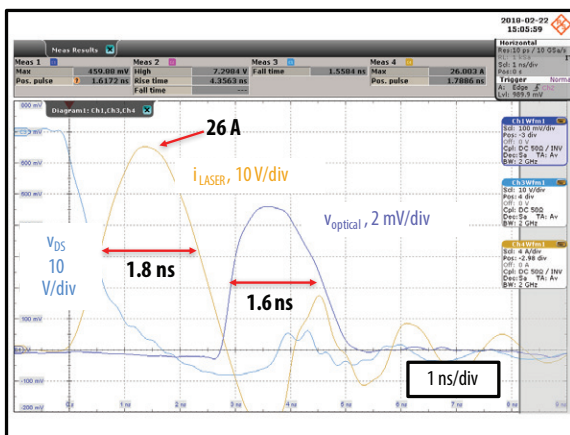

Figure 5. EPC2212 FET and Texas Instruments LMG1020 driving and Excelitas TPGAD1S09H surface mount triple junction laser

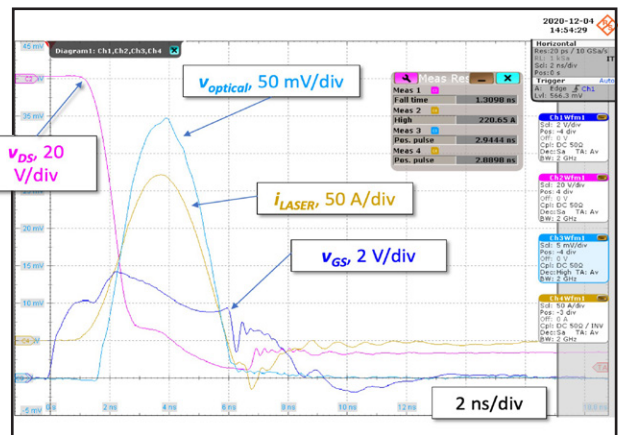

Figure 6. EPC2034C and Texas Instruments LMG1020 driving and Excelitas TPGAD1S09H surface mount triple junction laser

For More Information

Please contact info@epc-co.com or your local sales representative

Visit our website: epc-co.com

Sign-up to receive EPC updates at bit.ly/EPCupdates or text "EPC" to 22828



eGaN is a registered trademark of Efficient Power Conversion Corporation

